

SONY



VPL-XW7000ES

Native 4K | Laser with ACF Lens | 3,200lm

Bright, immersive entertainment
from a native 4K SXRD laser projector

VPL-XW7000ES

Bright, immersive entertainment from a native 4K laser projector.

Delivering extraordinary brightness, the VPL-XW7000ES brings an authentic big screen experience to your home. Enjoy crisp images full of lifelike colours, even in well-lit spaces like your media room or living room.



At a glance

- New Native 4K 0.61" SXR panel (3,840 x 2,160)
- 3,200 ANSI lumens
- Wide dynamic range optics
- X1 Ultimate for Projector
- IMAX Enhanced picture mode
- Compact chassis available in Black and White

All-new Native 4K SXR™ panel

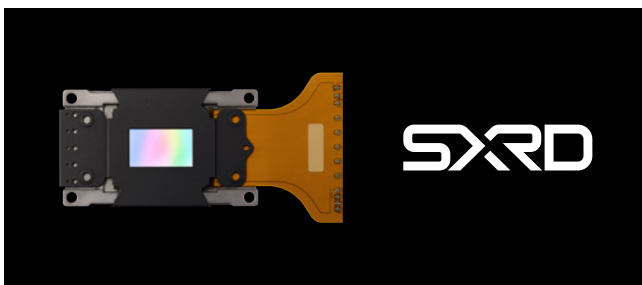

Experience incredibly lifelike pictures with native 4K that offers 8.3 million pixels (3,840 x 2,160). With an all-new 0.61-inch SXR panel, you'll enjoy high brightness, inky blacks, vibrant colours, rich tones and textures, plus clear cinematic motion and image smoothness.

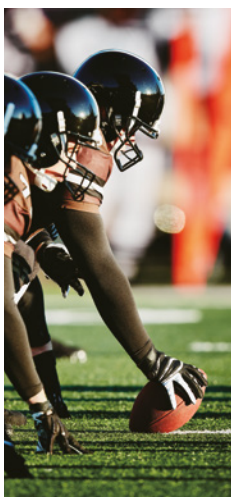

Live Colour Enhancer

With the newly developed Live Colour Enhancer, you'll enjoy lifelike skin tones and vivid images. The Live Colour Enhancer selectively expands the colour gamut, for vivid HDR images without unnatural oversaturation. Whether you're watching in daylight or a dark room, you can count on vibrant, true-to-life colours.

X1 Ultimate for Projector

Optimises our acclaimed BRAVIA TV video processing for projection. The incredible power of this video engine enables advanced data processing, with real-time enhancement of each on-screen object. The result is high dynamic range imagery with texture, colour, contrast and realism only available from Sony's home cinema projectors.



Advanced Crisp-Focused (ACF) Lens

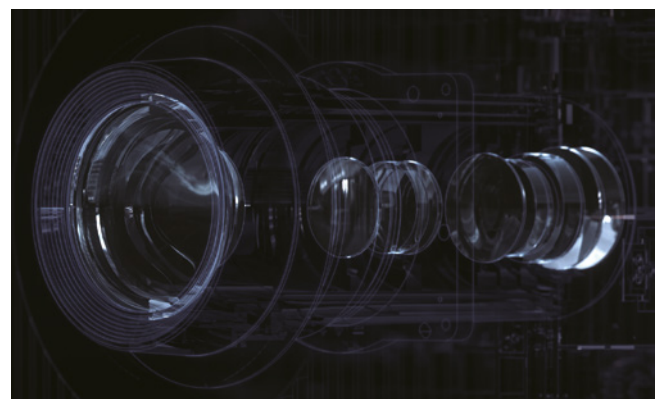

Enjoy flawless clarity across the entire screen, thanks to our all-new ACF Lens. The 70-mm aspherical front lens widens the focus area, ensuring clear images from corner to corner. A floating focus system utilises two moving lens groups and extra-low dispersion glass for distortion-free images with accurate colour reproduction.

IMAX Enhanced Picture Mode

Sony 4K projectors are compatible with IMAX Enhanced content, making them ready to deliver the bigger, more breathtaking IMAX visuals you love in compatible content. Take advantage of the size of your projector screen with movies that become even more immersive with IMAX Enhanced.

Triluminous Pro



See over a billion colours come to life with TRILUMINOS PRO. Our unique TRILUMINOS PRO algorithm can detect colour from saturation, hue and brightness to reproduce natural shades in every detail. You'll enjoy colours that are closer to those seen in the real world.

All new Wide Dynamic Range Optics

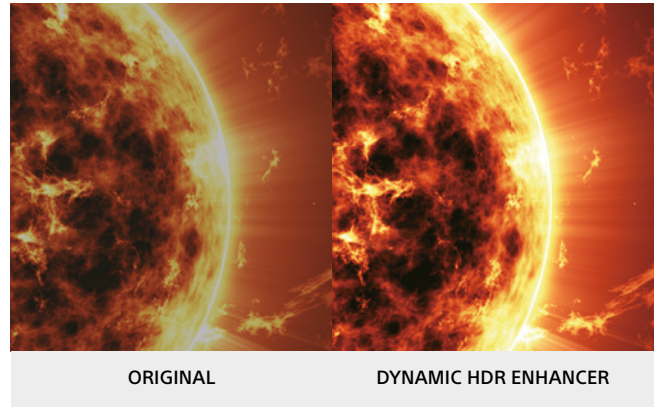

Our new Wide Dynamic Range Optics contribute to a compact design with better light control by maximising the potential of the laser light source. Enjoy higher colour volume with naturally colourful images and stunning contrast, even at high brightness levels.

Long-lasting 3,200 lm brightness

Immerse yourself in the large-scale action with bright and bold images. Engineered with our newly developed Native 4K SXRD™ (Silicon X-tal Reflective Display) panel and Wide Dynamic Range Optics, the VPL-XW7000ES delivers 200 nits* on a 150-inch screen —bringing you a truly immersive experience.

Projection distance

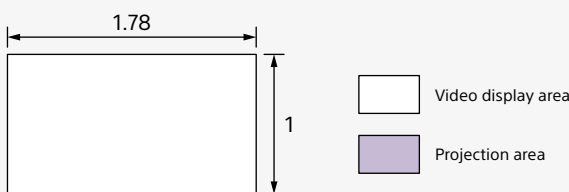

1.78:1 (16:9)		
Projection image size		Projections distance L
Diagonal	Width × Height	
60" (1.52m)	1.33m × 0.75m (52" × 29")	1.78m – 3.75m (70" – 147")
80" (2.03m)	1.77m × 1.00m (70" × 39")	2.38m – 5.02m (94" – 197")
100" (2.54m)	2.21m × 1.25m (87" × 49")	2.99m – 6.28m (118" – 247")
120" (3.05m)	2.66m × 1.49m (105" × 59")	3.60m – 7.55m (142" – 297")
150" (3.81m)	3.32m × 1.87m (131" × 74")	4.51m – 9.45m (178" – 372")
170" (4.32m)	3.76m × 2.12m (148" × 83")	5.12m – 10.72m (202" – 422")
200" (5.08m)	4.43m × 2.49m (174" × 98")	6.03m – 12.62m (238" – 496")
250" (6.35m)	5.53m × 3.11m (218" × 123")	7.54m – 15.78m (297" – 621")
300" (7.62m)	6.64m × 3.74m (261" × 147")	9.06m – 18.95m (357" – 746")

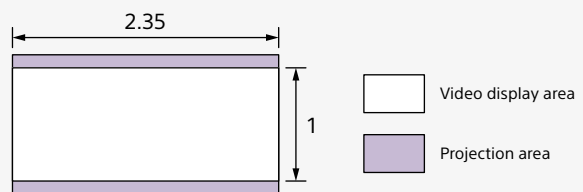

2.35:1		
Projection image size		Projections distance L
Diagonal	Width × Height	
60" (1.52m)	1.40m × 0.60m (55" × 23")	1.88m – 3.96m (74" – 156")
80" (2.03m)	1.87m × 0.80m (74" × 31")	2.52m – 5.30m (100" – 208")
100" (2.54m)	2.34m × 0.99m (92" × 39")	3.16m – 6.64m (125" – 261")
120" (3.05m)	2.80m × 1.19m (110" × 47")	3.80m – 7.97m (150" – 314")
150" (3.81m)	3.51m × 1.49m (138" × 59")	4.76m – 9.98m (188" – 393")
170" (4.32m)	3.97m × 1.69m (156" × 67")	5.40m – 11.32m (213" – 445")
200" (5.08m)	4.67m × 1.99m (184" × 78")	6.36m – 13.32m (251" – 524")
250" (6.35m)	5.84m × 2.49m (230" × 98")	7.97m – 16.67m (314" – 656")
300" (7.62m)	7.01m × 2.98m (276" × 117")	9.57m – 20.01m (377" – 788")

Specification

Display system	4K SXRD panel, projection system	
Display device	Size of effective display area	0.61" x 3
	Number of pixels	24,883,200 (3840 x 2160 x 3) pixels
Projection lens	Focus	Powered
	Zoom	Powered (Approx. x 2.1)
	Lens shift	Powered, Vertical +/- 85 %, Horizontal +/- 36 %
	Throw ratio*1	1.35:1 to 2.84:1
Light source	Laser diode	
Recommended lamp replacement time*2	-	
Light output	3,200 lm	
Dynamic contrast	∞ : 1	
Accepted digital signals	720 x 576/50p	3840 x 2160/24p
	720 x 480/60p	3840 x 2160/25p,
	1280 x 720/50p	3840 x 2160/30p
	1280 x 720/60p	3840 x 2160/50p
	1920 x 1080/50i	3840 x 2160/60p
	1920 x 1080/60i,	4096 x 2160/24p
	1920 x 1080/24p,	4096 x 2160/25p
	1920 x 1080/50p	4096 x 2160/30p
	1920 x 1080/60p	4096 x 2160/50p
	1920 x 1080/120p	4096 x 2160/60p
Input Output (Computer / Video / Control)	HDMI	x 2 (HDCP2.3)
	Display Port	-
	Trigger	x 1 (Mini jack, DC 12 V, Max. 100 mA)
	RS-232C	x 1 (D-sub 9-pin (male))
	LAN	x 1 (RJ-45, 10BASE-T/100BASE-TX)
	IR IN / OUT	IN: x 1 (Mini jack)
	3D SYNC OUT	x 1 (Mini jack)
	USB	x 1 (Type A, DC 5 V, Max. 500 mA)
Picture processor	X1™ Ultimate for projector	
Object-based HDR remaster	Yes	
Dynamic HDR Enhancer	Yes	
Object-based Super Resolution	Yes	
Dual database processing	Yes	
Digital Contrast Optimizer	Yes	
Digital Focus Optimizer	Yes	
Dynamic contrast control	Dynamic laser control	
Motionflow	Yes	
HDR Format	HDR10/HLG	
3D	Yes	
Picture position memory	3	
Input lag reduction	Yes (4K/2K)	
Acoustic noise*3	26 dB	
Power requirements	AC 100-240 V, 50/60 Hz	
Power consumption	420 W	
	Standby	0.3 W (when "Remote Start" is set to "Off")
	Networked Standby	0.5 W (LAN) (when "Remote Start" is set to "On") When a LAN terminal is not connected, it becomes a low power consumption mode.
Dimensions (Without Protrusions)	W 460 x H 210 x D 517 mm (W 18 1/8 x H 8 9/32 x D 20 11/32 in)	
Mass	Approx. 14 kg / 31 lb	
Supplied accessories	Remote Control (RM-PJ24), Size AA (R6) manganese batteries (2), AC Power Cord (1), Lens Cap (1), Setup Guide (1)	
Optional accessories	-	

Connector panel



Dimensions

Unit: mm (in)

Front

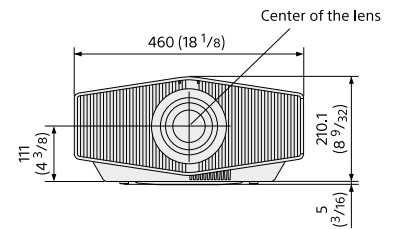

Bottom

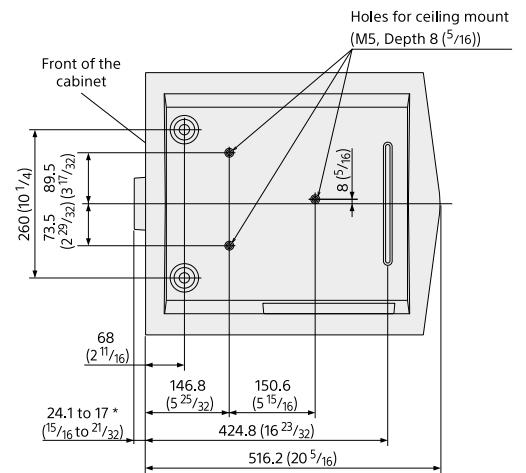

Optional accessories

X105-RF-X1

Xpand 3D Glasses



AE125-RF-PRO

Xpand 3D transmitter



*1 Display size: 16:9

*2 The figures are expected maintenance time and not guaranteed. They will depend on the environment or how the projector is used.

*3 Depends on the projector setting condition and usage environment.